

 **THERMO KING**

# SLXe

Single and Multi Temperature Refrigeration System for Trailers

e-volution  
e-nnovation  
e-fficient  
e-connect  
e-cological  
e-xpertise



 **Ingersoll Rand**

# CONTENT

SLXe: The next generation in transport refrigeration	3
e-volution	4
e-nnovation	5
e-fficient	6
e-connect	7
e-cological	8
e-xpertise	9
SR-3 controller, the key to total temperature management	10
Electronic Throttling Valve (ETV)	12
Options & Accessories	14
Features, options & accessories	16
Specifications	20
Multi Temperature Zones	22



# SLXe

## The next generation in transport refrigeration

This new range reflects Thermo King's depth of experience and expertise, from being pioneers to becoming leaders in the field of refrigerated transport.

Cutting edge technology optimises productivity by delivering low operating costs and maximum load protection.

The new SLXe brings significant innovations to maximise profitability while minimising environmental impact within a sustainable transport and delivery process.

The SLXe is available in a wide range of models to suit every need. Discover the full range: SLXe-100, SLXe-200, SLXe-300, SLXe-400, SLXe-Spectrum, SLXe-300 Ferry and SLXe-Whisper.



e-efficient  
e-connect e-revolution  
e-cological  
e-expertise e-innovation



SLXe-100

SLXe-200

SLXe-300

SLXe-400

SLXe-Ferry

SLXe-Spectrum

SLXe-Whisper

## e-evolution

Thermo King has responded to customer needs by evolving the proven SLX range.

- Even better corrosion protection is provided with the introduction of immersion electro coating (e-coat) for the unit frame.
- A special Ferry Version of the SLXe has been developed to deliver increased load protection during sea journeys thanks to an oversized electric stand-by motor for increased cooling capacity.
- A much extended range of accessories includes a tail lift battery charger and unit protection bars.
- Frame design has been enhanced for increased rigidity. Lower vibration levels give reduced mechanical stress on the unit and the trailer and more comfort for the driver.
- Thermo King's EON battery uses absorbed glass mat technology to withstand temperature extremes and give a lifespan up to five times longer than a conventional wet cell battery.
- The battery SafeGuard kit avoids the inconvenience of an accidentally discharged battery.
- A combo plug is supplied as standard for plug and play installation of the fuel level display.

4

# Easier installation

# Increased shelf life

# Reliable operation

# Reduced downtime



## e-nnovation

The SLXe embodies the latest technology to maximise performance and optimise productivity.

- The new Smart Reefer 3 (SR-3) controller is easier to use, has enhanced communication capabilities and is fully customisable for total temperature management.
- An electronic throttling valve (ETV) is available for both single and multi temperature applications, improving performance and temperature management.
- Microchannel heat exchanger technology makes condensers lighter and more corrosion resistant.
- A smaller refrigerant charge reduces environmental impact.



**Save time**  
**Easy to use**  
**Increased load protection**



## e-efficient

The SLXe range, just like its predecessors, has been designed to maximise efficiency and minimise total life costs to enable profitable operation.

- Most efficient use of energy: the compressor is directly driven by the engine to avoid all potential losses and maximise cooling per litre of fuel consumed.
- Independent stand-by electric motor for fuel saving and emission control.
- Optimised operating cycles combining faster temperature pull down with reduced fuel consumption.
- SR-3 controller with customisable menus, consistent with previous generation in order to minimise time spent in user training and provide a seamless transition.
- Many common components, reducing time required for drivers and service personnel to re-train and minimising parts stock levels.
- Easy servicing and Extended Maintenance Intervals (EMI 3000) to minimise time spent on maintenance and increase up-time.

Independent external stand-by electric motor:

Low operating cost, low noise, maximum dependability and energy efficiency. Available in oversize version for extra cooling capacity in ferry applications.



## Standard components

## Ease of maintenance



## e-connect

The new SR-3 controller comes with greatly extended communication capabilities. Asset management and data transfer are made easy. Optimum unit settings and temperature management profiles can be stored for future use.

- TracKing™ is a dynamic, web-enabled system that provides end-to-end visibility of refrigerated vehicles for total asset management.
- A USB port is provided as standard to allow easy and rapid data download, upload and flash load.
- The SR-3 is ready to support future wireless communication for yard management.
- OptiSet™ Plus allows pre-set operating parameters to be loaded by a Thermo King dealer. These are tailored to match unit performance to the precise and unique requirements of each load.



Visit Thermo King's TracKing™ website: [www.tktracking.com](http://www.tktracking.com)

Increased productivity  
Superior traceability  
Total asset management



## e-cological



The SLXe range offers the lowest environmental impact available on the market today. Operators can expect substantial reductions in exhaust emissions, operating noise and waste generated during the entire product life.

- Lowest fuel consumption on the market.
- Low emission GreenTech engine.
- ISO 14001 certified manufacturing plants.
- EMI 3000 extended maintenance intervals to reduce wastage and disposal of parts and lubricants.
- Microchannel heat exchanger technology means a smaller refrigerant charge and reduced environmental impact.
- Quietest diesel powered unit on the market. A fully PIEK certified version is also available.
- At end of life, 99.7% (by weight) of the unit is recyclable.

### SLXe Whisper

- PIEK Certified for almost silent operation.
- Can operate at high speed.
- Ideal for night-time deliveries in noise sensitive areas.



Lowest emissions  
Lowest noise levels





## e-xpertise

Thermo King patented the first transport refrigeration unit in 1938. Over 70 years later, it remains the uncontested world leader in transport temperature control. Such expertise enables the development of products which continue to meet and exceed customer expectations.

- Global experience in road, rail and maritime applications.
- Built with components which have been tested and proven over millions of operating hours in the harshest environments.
- Consistently shown to have highest resale value.
- Most extensive and experienced dealer service network, worldwide, available round the clock.



Extensive and  
experienced dealer  
network

High resale value

Proven components



# SR-3 controller, the key to total temperature management

While the new SR-3 controller boasts many new features, operators will find it retains the menus they have become familiar with using the predecessor SR-2. So the benefits of the SR-3 can be enjoyed with a seamless transition and minimal training. As always, an interactive tutorial is available for new drivers.

A simple, intuitive display with a choice of 23 languages is used for:

- Changing temperature set point
- Setting selectable alarms and menus
- Monitoring system performance
- Initiating a start of trip
- Viewing all zones at the same time
- Recording all operational parameters.

Load protection is ensured by a range of features including:

- Keypad with lock-out
- Mode-lock
- Phase-correction
- Diesel/electric auto switching
- Set point warning
- Wintrac™ software for data storage and analysis.

## Full suite of data recording, management and analysis tools

CargoWatch™ 

A high-performance data logger for full EU compliance. Since January 2006, data logging has been a European requirement for the transport of quick-frozen food (Regulation 37/2005). The SLXe comes with an on-board data logger as standard. To ensure your total compliance, CargoWatch™ is a fully approved independent logger featuring:

- Six temperature sensors
- Four door switches
- Humidity sensor
- Data averaging
- Programmable out-of-range alarms (optional)



# Easy to use, easy to customise

## Wintrac™

Easy-to-use Windows® based reporting package for simple, rapid data downloads, data search and generation of fully customisable reports in graphic or tabular format.

## OptiSet™ Plus

Pre-set operating parameters can be loaded by a Thermo King dealer. These are tailored to match unit performance to the precise and unique requirements of each load. This provides operating economy and load protection, while dramatically reducing the risk of operator error.

## ServiceWatch™

A service logger is integrated in the SR-3 and provided as standard.

- Enables faster and more accurate fault diagnosis
- Reduces downtime and labour hours
- Keeps a record of system operating modes and performance characteristics.

## Greatly extended communication capabilities

The SR-3 controller is designed to support high speed, flexible communication tasks including uploading temperature profiles or software upgrades and downloading temperature and diagnostic data.

The following will be supported for data transfer and management:

- Cable connection: when using a laptop with Wintrac™ software
- USB key: via the USB port provided as standard, eliminating the need for laptops and cables
- GPRS connection: via TrackKing™ tool which allows online fleet and temperature management
- Wireless communication: As end customers demand increasing temperature traceability, transporters need a simple and effective means of accessing critical data. The SR-3 is designed to facilitate yard management and is ready to support future wireless connections.



# Electronic Throttling Valve (ETV)

## Maximise performance and load protection

ETV technology is now available for both single and multi temperature SLXe models.

Fresh produce benefits from a continuous flow of cool, moist air and extra-precise control of critical box temperatures (temperature modulation). All operations enjoy faster temperature pull-down (saving valuable pre-cooling time) and reduced fuel consumption.

## How it works

Thermo King's ETV employs microprocessor technology to control the refrigeration system precisely. As the temperature approaches set-point, the ETV begins to close, throttling the refrigerant gas returning to the compressor and thus reducing its cooling/heating capacity. This process provides very smooth and steady temperature control, resulting in ideal conditions for sensitive fresh produce. Less thermal shock means less weight loss through evaporation and therefore longer product shelf life.

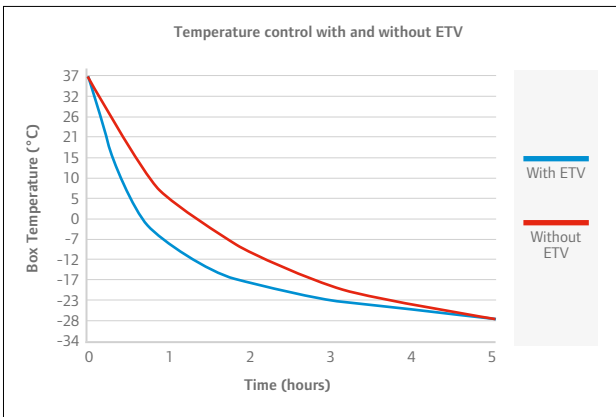

Faster pull-down.

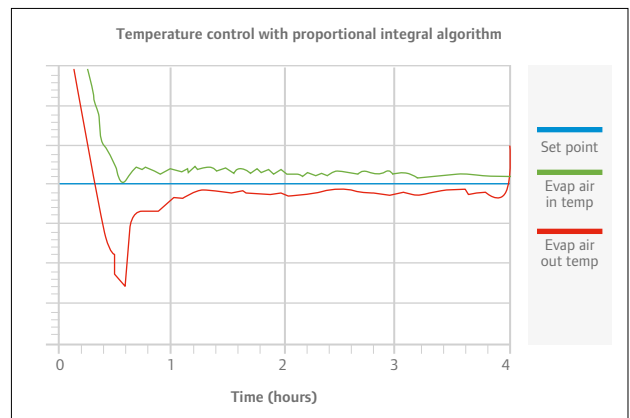
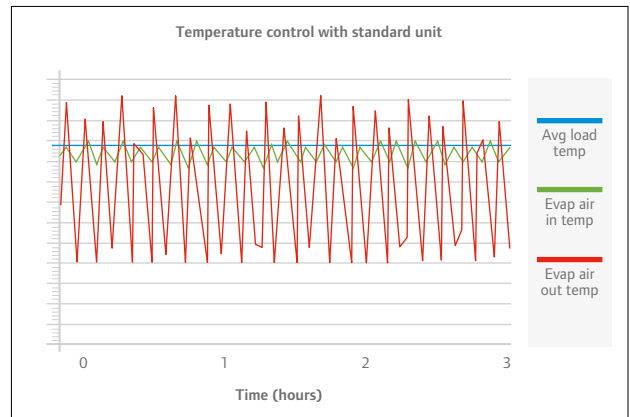

Tighter temperature control.

ETV gets your trailer to the right temperature faster

# ETV gets your trailer to the right temperature faster

## Temperature spikes

- Variations in discharge air temperature, or spikes, pose a serious threat to the quality and shelf-life of fresh products.
- Air that is much below set-point can result in surface freezing (“top freeze”) and severe product damage.
- Air that is much above set-point can cause dehydration and product shrinkage.

## Temperature modulation

Thermo King’s ETV technology prevents load damage by maintaining box temperature within 1.5°C of set-point. With ETV and temperature modulation, even sensitive loads retain their “just picked” freshness over extended journeys.

## Cycle-Sentry™ modulation

While some fresh produce needs continuous airflow in transit, others can enjoy the benefits of temperature modulation and the economies of Cycle-Sentry™ stop-start operation at the same time.

Fresh commodities with the following characteristics may be candidates for Cycle-Sentry™ modulation:

- Fresh commodities with a low heat of respiration
- Fresh commodities that do not ripen after harvest
- Fresh commodities that do not require continuous airflow.

The operation of Cycle-Sentry™ modulation can be easily managed with pre-set profiles in OptiSet™Plus.

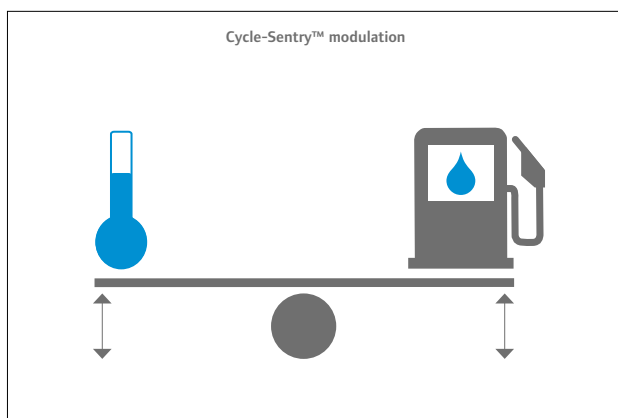

Cycle-Sentry is the optimum balance between temperature control and fuel consumption

# Options & accessories



## ■ TemperatureWatch

Allows the operator to monitor load temperature directly from the cab.

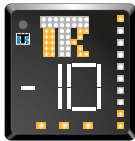

## ■ Combo display

Allows viewing of unit status and alarms directly from the driver's cab, including operating mode, box temperature and fuel level.

## ■ Oversized Stand-by Motor

Provides increased cooling capacity when diesel operation is not possible, such as on board a ship.



## ■ SR-3 controller

The key to total temperature management.



## ■ SafeGuard battery protection kit

Avoids a fully discharged battery and the resultant cost and inconvenience of downtime.



## ■ Fuel level display

High visibility LED display allows driver to monitor unit fuel tank level from the cab.



## ■ Protection Bars

Prevent impact damage to the unit panels while allowing easy access for maintenance and service.

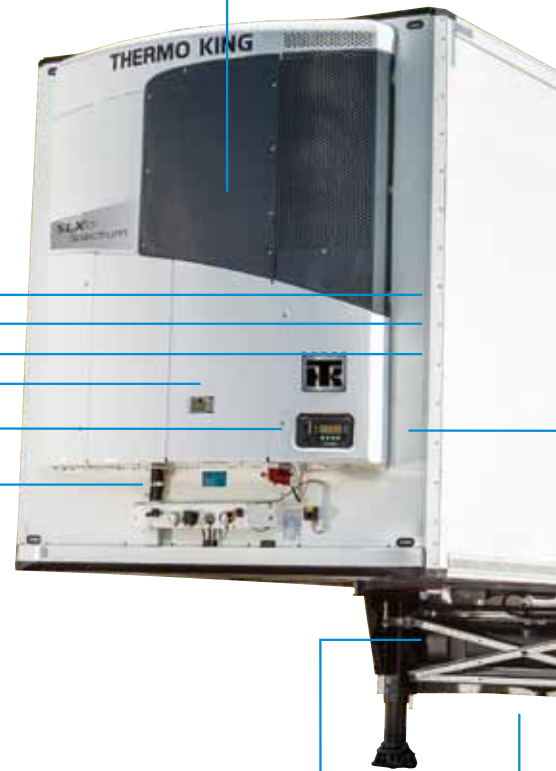

## ■ Fuel sensor

Uses the SR-3 to show the operator how much fuel remains in the tank and thus avoid nuisance shut-downs.

# Tracking

## Your intelligent remote monitoring system

Monitor sensitive loads via the web.



### AIA temperature sensor

High-accuracy roof-mounted sensor designed to withstand impact from fork-lift movements.

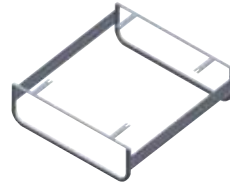

### Remote evaporator guard

To protect against accidental damage when loading and unloading.



### SR-3 rear remote control

Allows easy and safe control of the refrigeration unit from inside the rear of the trailer during loading.



### Slim-line door switch

Shuts down the unit when doors are open to reduce load temperature rise and save fuel. Unit restarts when doors are closed.



### Tail Lift Charger

Maintains the charge in tail-lift batteries by using the unit alternator.



### Polyethylene diesel fuel tank

- User-friendly and lightweight
- Impact and corrosion resistant
- Large 230 litre capacity
- Lockable filler caps for security
- Easy, quick and safe to fill from either side of the vehicle.

# Features, options & accessories

FEATURES AND OPTIONS	SLXe-100 SLXe-200	SLXe-300 SLXe-400 SLXe-Whisper	SLXe-300 Ferry	SLXe-300 Spectrum
<b>LIFE COST MANAGEMENT</b>				
ThermoKare™	●	●	●	●
Warranty coverage	●	●	●	●
EMI 3000: Extended maintenance interval	●	●	●	●
Thermo King high performance battery	●	●	●	●
Cycle-Sentry™	●	●	●	●
Independent stand-by motor	○	○	●	○
<b>DATA CAPTURE &amp; COMMUNICATIONS</b>				
SR-3 controller	●	●	●	●
SR-3 rear remote control	▲	▲	▲	▲
TKDL data capture	▲	▲	▲	▲
Wintrac™	▲	▲	▲	▲
TracKing™ (data analysis software)	▲ ●	▲ △	▲ △	▲ △
OptiSet™ Plus	●	●	●	○
<b>LOAD PROTECTION</b>				
Temperature modulation	○	●	●	●
Slim-line door switch	▲	▲	▲	▲
Diesel/electric auto switching	●	●	●	●
Autophase correction	●	●	●	●
SafeGuard battery protection kit	▲	▲	▲	▲
<b>CUSTOMIZATION</b>				
Remote evaporator guard	○	○	○	▲
Shock Protection Bars	▲	▲	▲	▲

○ Not Available    ● Standard Feature    △ Option: Factory Supplied    ▲ Option: Dealer Supplied





## ThermoKare™

Offers a comprehensive range of service contract options, helping to manage your maintenance costs and the total life cost of your unit.

## Warranty coverage

Two year warranty coverage on unit and options\*

\*second year coverage is conditional upon mid-term inspection

## EMI 3000: Extended maintenance interval

Extends maintenance intervals and reduces operating costs:

- Reduced clean-up and disposal costs
- Reduced environmental impact with less spillage and less oil, filter and coolant waste
- Extended engine life with improved, highly efficient oil filtration.

## Thermo King high performance battery

Designed specifically for the rigours of over-the-road transport temperature control applications. Silver-calcium technology extends service life to over 20% more than conventional batteries.

## Cycle Sentry™ modulation

Cycle-Sentry™ modulation offers an optimum combination between minimum fuel usage and tight temperature control when used with fresh commodities with specific characteristics.

## Independent stand-by motor

Significant fuel saving combined with emission and noise reductions when compared to diesel operation. The motor is external to the refrigeration circuit and is easily serviceable and replaceable.

## SR-3 controller

Easy to use, easy to customise. The key to total temperature management.

## Auto phase correction

Safeguards the load against reverse fan rotation while on electric stand-by.

## Diesel/electric auto switching

Automatically starts diesel engine if electric stand-by fails. Manual override for ferry operation. No manual intervention needed.

## OptiSet™ Plus

Pre-set operating parameters can be loaded by a Thermo King dealer. These are tailored to match unit performance to the precise and unique requirements of each load. This provides operating economy and load protection, while dramatically reducing the risk of operator error. Parameters include:

- Set point
- Temperature range
- Operating mode (Cycle-Sentry / continuous run)
- Produce Protection Plus
- Discharge Air Control

## Temperature modulation

Prevents temperature spikes thus avoiding both top freezing and dehydration resulting in shrinkage. Sensitive loads retain their “just picked” freshness over extended journeys.

## Discharge Air control

Safeguards fresh produce by keeping discharge air temperatures close to set point. The feature is selectable and effectively eliminates the risk of load damage by top freezing.

# Features, options & accessories

## SR-3 rear remote control

- Allows easy control of the refrigeration unit from inside the rear of the truck
- Enables energy efficient and safe loading

## Slim-line door switch

Shuts down the unit when the doors are open to reduce load temperature rise and save fuel.

## SafeGuard battery protection kit

Avoids a fully discharged battery and the resultant cost and inconvenience of downtime.

## Protection bars

Prevent impact damage to the unit panels while allowing easy access for maintenance and service. Especially recommended for trailers which are loaded on ferries.

## Remote evaporator guard

Protects evaporators against accidental damage when loading and unloading the trailer.

## TKDL data capture

User-friendly temperature recorders for all makes of temperature-controlled equipment

Simple data download to PC

- Delivery and journey printouts at the touch of a button
- Approved to EN-12830, CE Mark and IP-65 standards
- Up to four independent sensors
- Up to one year's data storage capacity.

## Wintrac™ (data analysis software)

User-friendly software offers fleet managers automatic and customised reporting of temperature and operational data, logged by DAS or transmitted by TrackKing™.







## TrackKing™

Provides comprehensive load monitoring and fleet tracking functions. Monitors sensitive loads via the web, increasing vehicle asset utilisation, reducing operating costs, enhancing end customer satisfaction, increasing security and reducing insurance risk. TrackKing™ Can be sold with a ThermoKare™ service contract. TrackKing™ is compatible with all Thermo King data loggers and controllers.

More information at [www.tktracking.com](http://www.tktracking.com)



# Specifications

SPECIFICATIONS		SLXe-100	SLXe-200	SLXe-300	SLXe-300 Ferry	SLXe-400	SLXe- Whisper	SLXe- Spectrum							
<b>REFRIGERATION CAPACITY: SYSTEM NET COOLING CAPACITY AT 30°C AMBIENT TEMP. UNDER A.T.P. CONDITIONS</b>															
Return air temperature to evaporator	°C	0°C	-20°C	0°C	-20°C	0°C	-20°C	0°C	-20°C						
Capacity on engine power	W	10000	5900	13400	7800	15000	8100	15000	8100	17400	9300	13600	7400	17640	9638
Capacity on electric stand-by	W	8800	5300	9600	5900	11700	6100	11700	6100	12500	6900	11000	5900	10600	6550
<b>HEATING CAPACITY: BOX TEMPERATURE + 2°C</b>															
Outside air temperature	°C	-10°C	-20°C	-10°C	-20°C	-10°C	-20°C	-10°C	-20°C	-10°C	-20°C	-10°C	-20°C	-10°C	-20°C
Capacity on engine power	W	7100	6500	8200	7500	12000	12000	12000	12000	13200	13400	10900	11000	12000	12000
<b>AIRFLOW: ON HIGH SPEED ENGINE OPERATION</b>															
Airflow volume @ 0 Pa static pressure	m³/hr	4250	5000	5000	5000	5000	5500	4555	5000						
Airflow volume in fully loaded trailer	m³/hr	3740	4680	4680	4680	4680	4680	4220	4680						
Discharge velocity (air throw)	m/sec	12	14	14	14	14	14	13	15						
<b>WEIGHT: INCLUDES BATTERY</b>															
Model 30: cooling and heating on engine operation	kg	743	770	772	N.A.	772	772	794							
Model 50: cooling and heating on engine & electric stand-by operation	kg	798	825	825	835	826	826	848							
<b>ENGINE: LOW EMISSION, 4 CYLINDER, LIQUID COOLED</b>															
Model		TK486V 	TK486V 	TK486V 	TK486V 	TK486V 	TK486V 	TK486V 							
Rating	kW	19.5	19.5	19.5	19.5	23.5	19.5	23.5							
Maintenance interval	hrs	3000	3000	3000	3000	3000	3000	3000							
<b>COMPRESSOR: LIGHTWEIGHT ALUMINIUM ALLOY, 4 CYLINDER, WITH BY-PASS OIL FILTER</b>															
Model		X426 C5	X430 C5	X430 C5	X430 C5	X430 C5	X430 C5	X430 C5							
Displacement	cc	424	492	492	492	492	492	492							
<b>ELECTRIC STAND-BY MOTOR</b>															
Voltage / phase / cycles		400/3/50	400/3/50	400/3/50	400/3/50	400/3/50	400/3/50	400/3/50							
Rating	kW	9.3	9.3	9.3	14.7	9.3	9.3	9.3							
<b>REFRIGERANT: R-404A ZERO OZONE DEPLETION POTENTIAL (ODP), INTERNATIONALLY APPROVED</b>															
Charge	kg	4	5	5	5	5	5	7.5*							

Specifications are subject to change without notice.

\*Refrigerant charge can vary depending on the multi-temperature zone plans.

REMOTE EVAPORATORS		S-2		S-3		S-2 + S-2		S-3 + S-3	
<b>REFRIGERATION CAPACITY: SYSTEM NET COOLING CAPACITY AT 30°C AMBIENT TEMPERATURE UNDER A.T.P. CONDITIONS</b>									
Return air to evaporator		0°C	-20°C	0°C	-20°C	0°C	-20°C	0°C	-20°C
Capacity	W (up to)	7000	4200	8900	5200	11300	6600	13200	7900
<b>AIRFLOW</b>									
Airflow volume @ 0 Pa static pressure	m <sup>3</sup> /hr	1330		2000		2700		4000	
Discharge velocity (air throw)	m/sec	9.5		9.5		9.5		9.5	
<b>WEIGHT</b>									
	kg	36		51		72		102	

## Dimensions (mm)

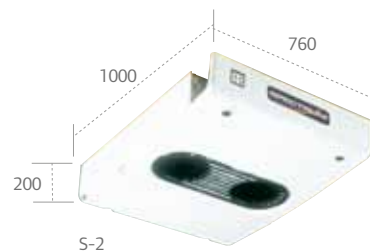
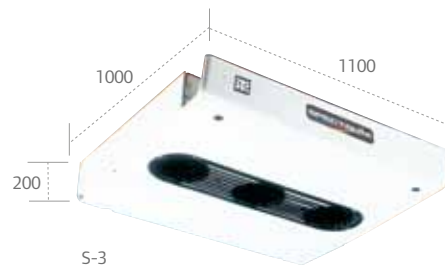

## WARRANTY SUMMARY

Specific terms of the Thermo King Ireland Ltd. 24 month full warranty (TK 60186-2-WA) are available on request. Thermo King excludes liability in contract and tort (including strict liability and negligence) for any special, indirect or consequential damages by reason of the installation or use of any covered product or its mechanical failure.



# Multi Temperature Zones

## 2 Zones

TEMPERATURE		ZONE 1		ZONE 2			
		HOST UNIT		REMOTE EVAPORATOR			
		Airflow	Refrigeration Capacity <sup>(1)</sup>	Model	Airflow	Maximum Dimensions <sup>(2)</sup>	Refrigeration Capacity <sup>(1)</sup>
(°C)		(m <sup>3</sup> /h)	(W)		(m <sup>3</sup> /h)	(meter)	(W)
A	0/30°C	5000	15800	S2	1330	a = 3.5	7300
	-20/30°C		8550				4350
B	0/30°C	5000	15800	S3	2000	a = 5.3	9150
	-20/30°C		8550				5350
C	0/30°C	5000	15800	S2-S2	2700	a = 7.1	14600
	-20/30°C		8550				8750
E	0/30°C	5000	15800	S3-S3	4000	a = 9.5	17650
	-20/30°C		8550				9250
G	0/30°C	5000	15800	S2	1330	a = 0.8	7300
	-20/30°C		8550			b = 9.5	4350
H	0/30°C	5000	15800	S2-S2	2700	a = 0.8	14600
	-20/30°C		8550				8750
I	0/30°C	5000	15800	S3	2000	a = 1.25	9150
	-20/30°C		8550			b = 9.5	5350
J	0/30°C	5000	15800	S3-S3	4000	a = 1.25	17650
	-20/30°C		8550				9250

<sup>(1)</sup> Individual capacity of each zone

<sup>(2)</sup> Maximum Recommended Dimensions: These are guidelines based on airflow and air velocity requirements. For each application, a heat load calculation must be performed. All calculations are based upon the following assumptions: Trailer wall k value = 0.4W/m<sup>2</sup>K, Internal trailer length up to 13.5m, height up to 2.5m, width up to 2.5m, Zero heat load from produce carried, For information on configurations not shown here, contact your Thermo King Area Sales/Service Manager.

## Zone plans

### 2-Zone Adjustable

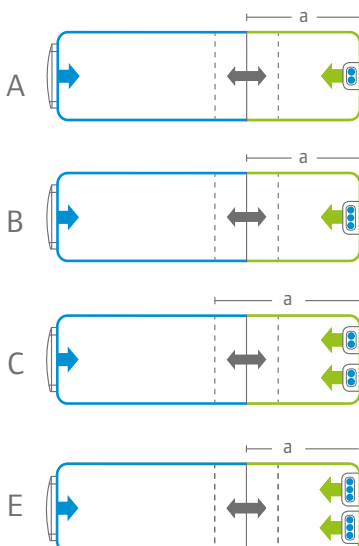

### 2-Zone Lane

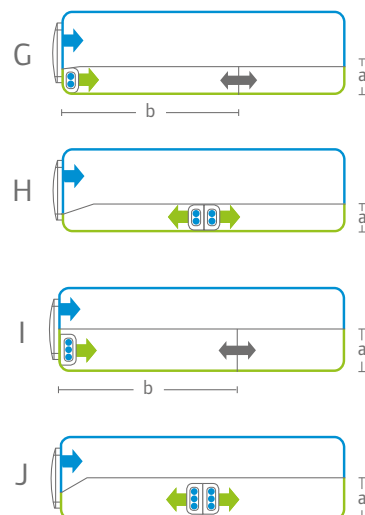

### 3 Zones

TEMPERATURE		ZONE 1		ZONE 2			ZONE 3				
		HOST UNIT		REMOTE EVAPORATOR			REMOTE EVAPORATOR				
	(°C)	Airflow (m <sup>3</sup> /h)	Refrigeration Capacity <sup>(1)</sup> (W)	Model	Airflow (m <sup>3</sup> /h)	Maximum Dimensions <sup>(2)</sup> (meter)	Refrigeration Capacity <sup>(1)</sup> (W)	Model	Airflow (m <sup>3</sup> /h)	Maximum Dimensions <sup>(2)</sup> (meter)	Refrigeration Capacity <sup>(1)</sup> (W)
M	0/30°C	5000	15800	S2	1330	a = 3.5	7300	S2	1330	b = 3.5	7300
	-20/30°C		8550				4350				4350
N	0/30°C	5000	15800	S3	2000	a = 5.3	9150	S3	2000	b = 5.3	9150
	-20/30°C		8550				5350				5350
O	0/30°C	5000	15800	S3	2000	a = 5.3	9150	S2	1330	b = 3.5	7300
	-20/30°C		8550				5350				4350
P	0/30°C	5000	15800	S2-S2	2700	a = 7.1	14600	S3	2000	b = 5.3	9150
	-20/30°C		8550				8750				5350
Q	0/30°C	5000	15800	S3-S3	4000	a = 9.5	17650	S3	2000	b = 5.3	9150
	-20/30°C		8550				9250				5350
R	0/30°C	5000	15800	S2	1330	a = 9.5	7300	S2	1330	b = 9.5	7300
	-20/30°C		8550				4350				4350
U	0/30°C	5000	15800	S2	1330	a = 9.5	7300	S3	2000	b = 8.0	9150
	-20/30°C		8550				4350				5350

<sup>(1)</sup> Individual capacity of each zone

<sup>(2)</sup> Maximum Recommended Dimensions: These are guidelines based on airflow and air velocity requirements. For each application, a heat load calculation must be performed. All calculations are based upon the following assumptions: Trailer wall k value = 0.4W/m<sup>2</sup>K, Internal trailer length up to 13.5m, height up to 2.5m, width up to 2.5m, Zero heat load from produce carried, For information on configurations not shown here, contact your Thermo King Area Sales/Service Manager.

### Zone plans

#### 3-Zone Adjustable

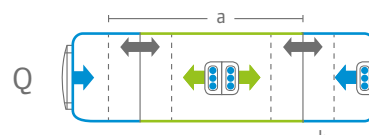
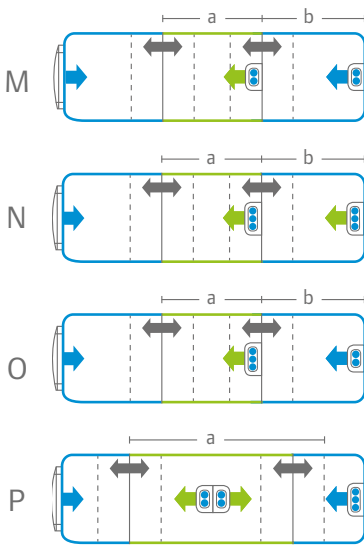

#### 3-Zone Lane

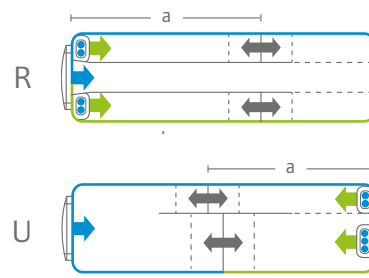



europe.thermoking.com



For further information please contact:

---



Thermo King® is a brand of Ingersoll Rand. Ingersoll Rand (NYSE:IR) advances the quality of life by creating and sustaining safe, comfortable and efficient environments. Our people and our family of brands — including Thermo King®, Trane®, Ingersoll Rand®, Club Car® and Schlage® — work together to enhance the quality and comfort of air in homes and buildings; transport and protect food and perishables; secure homes and commercial properties; and increase industrial productivity and efficiency. We are a \$14 billion global business committed to a world of sustainable progress and enduring results.



ingersollrand.com

Ingersoll Rand - Lenneke Marelaan 6, B-1932 Sint-Stevens-Woluwe, Belgium.

© 2012 Ingersoll-Rand Company Limited TK 65000 (09-2012)-EN